

190-858-190 54" Dozer Blade (1991)
54" Dozer Blade

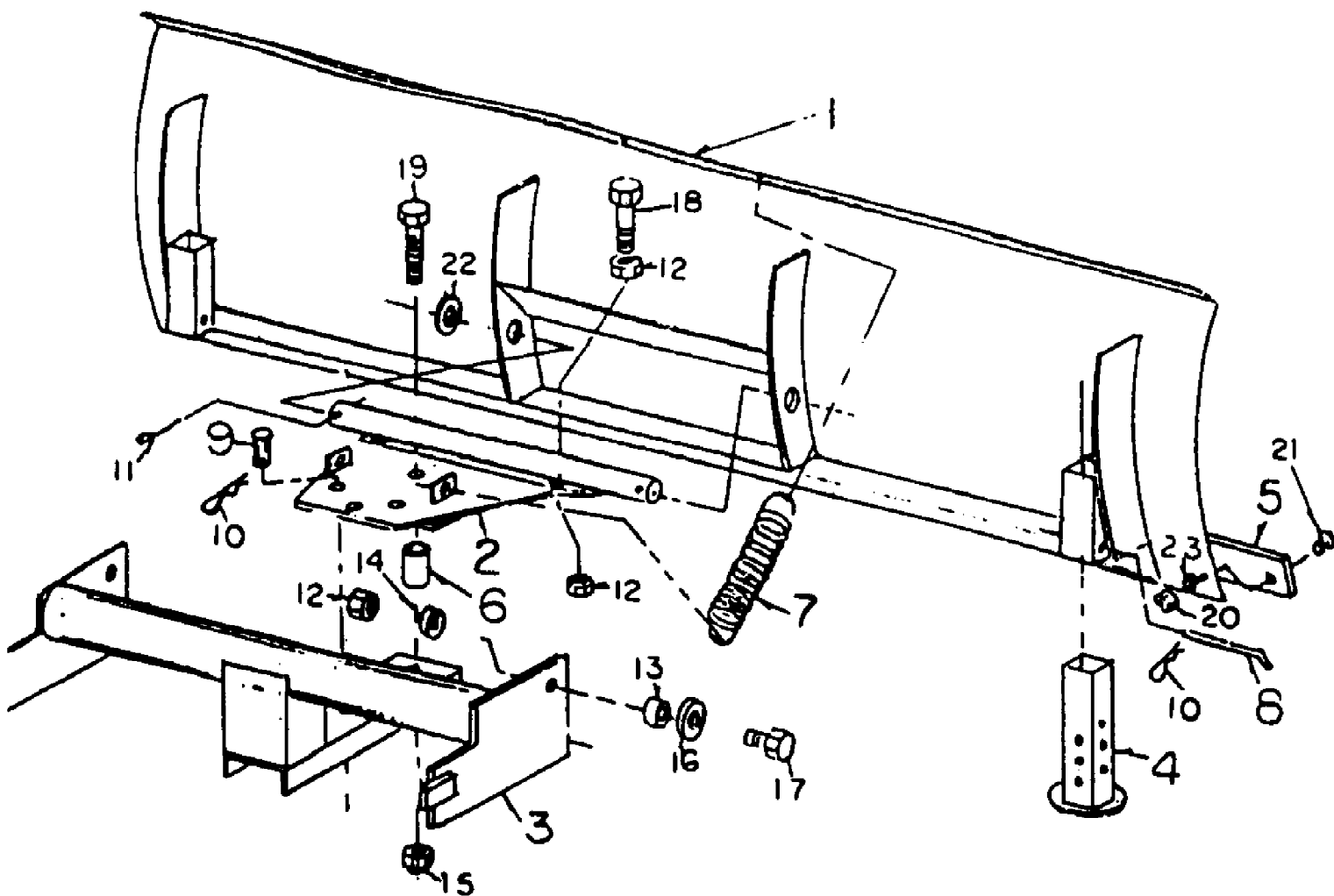

190-858-190 54" Dozer Blade (1991)
54" Dozer Blade

Page 2 of 2

Ref #	Part Number	Qty	S/P/F	Description
1	WD-440-0000	1		Blade, 54"
2	WD-440-0001	1		Pivot Mount
3	WD-440-0002	1		Blade Mount, 54"
4	WD-440-0004	2		Skid Plate
5	WD-440-0003	1		Replaceable Blade
6	WD-440-0005	1		Bushing
7	WD-900-5516	2		Spring
8	WD-900-5536	2		Pin, 3/8"
9	WD-900-5607	1		Clevis Pin, 1/2"
10	WD-900-5520	3		Hair Pin
11	WD-900-6178	2		Cotter Pin, 3/16" x 1"
12	WD-900-6125	6	S	Hex Nut, 1/2-13
13	WD-300-00135	1		Bushing
14	WD-900-6127	1	S	Lockwasher, 1/2"
15	WD-900-6126	1		Hex Locknut, 1/2"
16	WD-900-6128	1		Flatwasher, 1/2"
17	WD-900-6130	1		Hex Capscrew, 1/2-13 x 1 1/2", GRS
18	WD-900-6131	1		Hex-Capscrew, 1/2-13 x 2 1/4", GRS
19	WD-900-6132	1		Hex Capscrew, 1/2-13 x 3", GRS
20	WD-900-6050	1		Hex Nut, 5/16-18
21	WD-900-6057	1		Carriage Bolt, 5/16-18 x 1"
22	WD-900-6003	1		Machine Washer, 3/4"
23	WD-900-6051	1		Lockwasher, 5/16"